

Installation, Operating and Maintenance Instructions

# FORCEFLOW

**900 Series**  
Fan Convectors

**H2 SELECT & CB RANGE**



## **Copyright and trademarks**

All the information and drawings in this manual are the property of Biddle and may not be used (other than for the actual operation of the device), photocopied, duplicated, translated and/or be brought to the attention of third parties without Biddle's prior written permission.

The name Biddle is a registered trademark.

## **Warranty and Liability**

Please refer to Biddle's Terms And Conditions of Sale for warranty and liability conditions.

Biddle excludes liability for consequential loss at all times and under all circumstances.

## **Liability for the contents of this manual**

However, much care might have been taken in ensuring the correctness and, where necessary, completeness of the description of the relevant parts, Biddle disclaims all liability for damage resulting from any inaccuracies and/or deficiencies in this manual.

Should you detect any errors or ambiguities in this manual then we would be pleased to hear from you: it will help us to improve our documentation even further.

Biddle retains the right to change the specifications stated in this manual.

## **For more information**

If you have any comments or questions about specific topics relating to this product, please do not hesitate to contact Biddle.

## **UK Address**

Biddle Air Systems  
St. Mary's Road,  
Nuneaton,  
Warwickshire,  
CV11 5AU  
United Kingdom

Tel: 024 7638 4233  
E-mail: [sales@biddle-air.co.uk](mailto:sales@biddle-air.co.uk)  
Internet: [www.biddle-air.co.uk](http://www.biddle-air.co.uk)

## Contents

Introduction .....	4
Safety Information Before Starting Work .....	4
Storage.....	5
Transport .....	5
Installation .....	5
Unit Positioning and Accessibility .....	5
Installing the Unit.....	5
Connecting to central heating system.....	6
Connecting the Electrical Supply .....	6
Connecting External Controls .....	7
Commissioning and Setting to Work.....	7
Operation.....	7
Electrical Data .....	8
Changing the Unit Handling .....	9
Maintenance & Procedures.....	10
Maintenance Schedule.....	10
Filters.....	11
Fan Deck Replacement.....	11
Coil Maintenance and Removal .....	11
Spares .....	12
Wiring Diagrams.....	12

## Introduction

The Forceflow fan convector detailed in this instruction manual has been purpose built to provide comfort heating for environments where they have periodic occupancy, requiring fast heat up times and using less wall space than conventional radiators.

This document covers the installation, operation and maintenance of the units and is to be handed over to the end user to ensure the product is maintained over its working life.

Information regarding unit capacities and general dimensional information can be obtained from the sales literature available from the Biddle website or available on request from the sales office.

The product is only for indoor use where dry conditions can be guaranteed, in an ambient temperature range of 5°C – 40°C, and at altitudes not exceeding 500m above sea level.

## Safety Information Before Starting Work

Fan convectors are typically installed as part of a hot water system. When carrying out work on any part of this system, the competent person should ensure that the whole system is considered and not solely the equipment being worked on.

The installer is responsible for ensuring:

- The equipment has been installed in a safe and suitable manner with consideration for the immediate environment and ongoing maintenance that will be required to maximize the working life of the unit.
- The installation is in-line with the manufacturer's instructions and consideration of industry best practice and in agreement with all applicable statutory legislation and regulations.
- The work is carried out by competent workers who have fully read and understand these instructions, the scope of work and who have the required tools, equipment, and personal protective equipment to minimize risks.
- The product is installed, such that children of less than 3 years should be kept away unless continuously supervised. Where this is not possible and higher water temperatures are used Biddle recommend the unit's casework should be tested to ensure that it doesn't become too hot with the potential to cause burns. Children aged from 3 years and less than 8 years shall only switch on/off the appliance provided that it has been placed or installed in its intended normal operating position and they are supervision or have been given instruction concerning use of the appliance in a safe way and understand the hazards involved. Children aged from 3 years and less than 8 years shall not plug in, regulate, clean the appliance or perform user maintenance (as stated in EN 60335-2-30 clause 7.12). Where operation of the product is to be limited to certain persons only, Biddle offer a range of hidden and tamperproof controls.
- This product can be used by children aged from 8 years and above and persons with reduced physical, sensory or mental capabilities or lack of experience and knowledge if they have been given supervision or instruction concerning the use of the product in a safe manner (as stated in EN 60335-1 clause 7.12).



**Caution – When this product is connected to hot water pipework, elements of the product can become hot and exposed internal parts and pipework may cause burns. Particular attention has to be given where children and vulnerable people are present to ensure that exposed surfaces are sufficiently insulated (see BS EN 60335 parts 1 and 30 clause 7.12). For more information please contact Biddle using the contact details on the last page.**

Qualified and professional personnel should be used in all instances to determine exact methods of working using these instructions as a guide to good practice.

## Storage

The product must be drained before being stored in a dark, dry, frost-free, and well-ventilated place out of the reach of children. Storage temperatures should be between 0-40°C. The original packaging should be used for long-term storage.

## Transport

Prior to transporting the product, it should be removed and stowed safely to not incur damage. The original packaging should be used wherever possible, and the product should be protected from any significant temperatures or vibration.

## Installation

### Unit Positioning and Accessibility



**Caution – When this product is connected to hot water pipework, elements of the product can become hot and exposed internal parts and pipework may cause burns. Particular attention has to be given where children and vulnerable people are present to ensure that exposed surfaces are sufficiently insulated (see BS EN 60335 parts 1 and 30 clause 7.12). For more information please contact Biddle using the contact details on the last page.**



**It is the installer's responsibility to ensure that the operational and environmental limitations of the equipment meet with the project requirements.**

The installer should choose a suitable place to install the unit, noting clearance requirements for servicing and maintenance as detailed below:

An access panel is located on the unit and secured by at least two screws, or key locks, the full width of the unit. The unit must be installed such that this panel can be removed, and full access can be achieved to all internal components.

Each unit is supplied with a serial number marked on the data label on the inside of the unit which is visible once the access panel is removed. This information on here may be required to help identify the unit.



**Failure to provide adequate access will prevent adequate servicing and maintenance of the unit that can negatively impact the life expectancy of the unit and any warranty.**

### Installing the Unit

None of the connection points, coil connections/controls enclosure, are designed to be load bearing or support external equipment during installation or thereafter.

Each unit is provided with four fixed mounting points, that are to take the full weight of the unit. Mechanical fixings must be used to fix the appliance - adhesives are not deemed suitable.

In normal operation the unit will not exhibit a significant level of vibration, however vibration mitigation treatment may be necessary in certain situations. Where units are installed with vibration limiting equipment, flexible connections should be applied to all other services connected.

Remove the access panel by unscrewing the 2 x retaining screws, or unlocking the 2 x key operated locks, within the front of the casing.

Securely fix the unit to the wall or ceiling using the four fixing holes on the rear.

Check whether the water connections are on the most appropriate side of the unit. If not, change the 'handing' following the instructions later in this manual.

## Connecting to central heating system

**The unit incorporates a water to air heat exchanger with provision to connect to a central heating system.**

The coil is designed as counterflow operation and is used to maximise thermal performance whilst minimising energy consumption. The coil connections must be damage free before installing the unit, and care must be taken not to create any undue stress which may cause a fracture to the copper tails.

Connect flow and return pipework to the 3/4" Female BSP coil connections, with the water flow connection on the air leaving side of the coil. Alternatively, if specified at time of order, the unit will come with a factory fitted radiator valve set to facilitate easier balancing and isolation of the unit. The connection to these valves is 22mm compression and pipework should enter into the casing through the connections hole.

Once the pipework has been filled, check for leaks and with only room temperature water in the coil, test and vent the coil to expel any air from the system.

Coils must be protected from extreme temperatures that would result in freezing and damage to the copper pipes. The maximum operating pressure of the coil is 6 Bar (600kPa).



**It is the installer's responsibility to check and ensure that water has been treated with a suitable inhibitor and meets with the requirement of the project.**



**It is the installer's responsibility to ensure all relevant industry standards and codes of practice are followed and must conform to all statutory legislation or regulations that are applicable.**

## Connecting the Electrical Supply

**The electrical installation must conform to all relevant Standards.**

The equipment is intended to be connected to a 230 VAC 50 Hz electrical supply.

The power supply must be via a single-phase local isolator (customer supplied) with a contact separation on both Live and Neutral poles of at least 3mm. Please note the isolator must be fitted within an accessible position and labelled accordingly.



**Leader/Followers products may have multiple power supplies going to the unit. Ensure the unit is sufficiently labelled to make it clear that all supplies must be isolated before work can commence.**

The equipment is provided with a loose cable gland for connection via a suitable 3 core cable from the local fused spur. If the supply cord is damaged it must be replaced by the manufacturer, its service agent or similarly qualified person to avoid a hazard.

Remove the black/yellow electrics box by unscrewing the 2x retaining M5 hex bolts.

The connection block is clearly labelled with L (Live), N (Neutral) and  (Earth).

Once installed, care must be taken to ensure that the fixed wiring insulation is protected from hot surfaces by either positioning it away from the surfaces, or using insulating sleeving with an appropriate temperature rating.

## Connecting External Controls

Please refer to the sales order acknowledgement and/or delivery note for any separate external controls that need to be fitted. How to wire these to the product can be found on the wiring diagram supplied with the unit.

Feed the power supply cable, and any other necessary wires (e.g., remote switch box, remote thermostats etc.), through the casing utilising the cable gland supplied, and use the plug supplied to blank off the hole on the opposite end of the unit. Refit the black/yellow electrics box once the work has been completed.

## Commissioning and Setting to Work

1. With the unit isolated, the following should be checked:-
  - a. Check filter is clean and free from dust
  - b. Check coil is clean and free from obstructions
  - c. Hand spin fans to ensure no damage has occurred
  - d. Check all water connections for leaks
  - e. Vent the coil to ensure that any trapped air is vented
  - f. Check that all access panels are in place
  - g. Check that the controls enclosure is secure
  - h. Check operational isolators and controls
2. Supply power to the unit and set the neon on/off switch to the 'on' position.
3. Set the speed control switch, typically, to the 'low' position.
4. Set the summer/winter switch to the appropriate position.
5. Set the on/off thermostat to, typically, 20°C.
6. Set the speed change thermostat (if fitted) to typically, 4°C lower than the T1 setting.
7. Set the adjustable T4 pipe thermostat (if fitted) to a temperature 5-10°C lower than the system flow temperature. Where heat pumps and other lower temperature heating sources are used, take care to ensure the temperature is still above a 'hot room' temperature, to avoid false readings.
8. Re-fix the access panel and any covers to tamperproof thermostats.

## Operation

Controls are either built into the unit as part of the electrics box, and concealed behind the access panel, or supplied loose for remote fixing on site. Only those concealed behind the access panel should be operated by competent persons due to the presence of live voltages within the casing.

On/off (T1) thermostat – this is usually set to around 20°C. Once room temperature reaches this setting the fans automatically switch off.

Speed change (T2) thermostat – this is usually set to 4°C lower than the T1 setting. If the speed control switch is in the 'low' position, the fans automatically run at medium speed when the room temperature is below this setting and at low speed when room temperature is above this setting.

Low temperature cut out (T4) thermostat – clipped on to the pipework (or coil) of the unit, this monitors the temperature of the water and automatically turns the fans off when it drops below circa 40°C. Adjustable types are available for sites where the water flow temperature is lower to allow the user to set the level.

On/off switch – the unit can be switched on or off using the neon rocker switch/remote slider.

Speed control switch - the unit can be set to run at one of three fan speeds. However, it is usual to set the rocker switch to the 'low' position/remote slider to position 1.

Summer/winter switch – when the rocker switch is set in the ‘summer’ position/remote slider to the position it over-rides the low limit cut out (T4) thermostat and the on/off (T1) thermostat. This allows the unit to continually re-circulate ambient air when heating is turned off.

When heating is required, the rocker switch should be set in the ‘winter’ position (remote switch box slider to the ❄️ position). However, the fans will not operate until a water temperature of at least 40°C (or other if the adjustable option is used) is detected by the low limit cut out (T4) thermostat.

## Electrical Data

Model	Full Load Current (Amps)	Start Current (Amps)
915	0.33	0.47
930	0.49	0.68
935	0.49	0.67
940	0.5	0.68
975	1.7	3.55

Model	Full Load Current (Amps)	Start Current (Amps)
915 EC	0.16	0.16
930 EC	0.25	0.25
935 EC	0.25	0.25
940 EC	0.25	0.25
975 EC	1.0	1.0

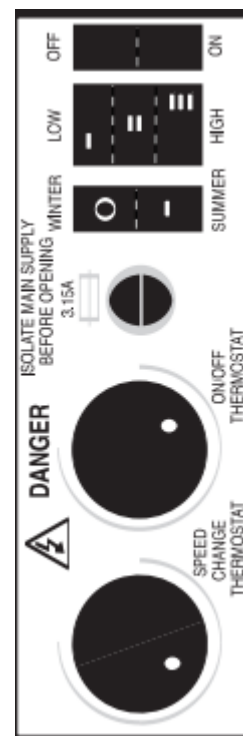

Remote switch box

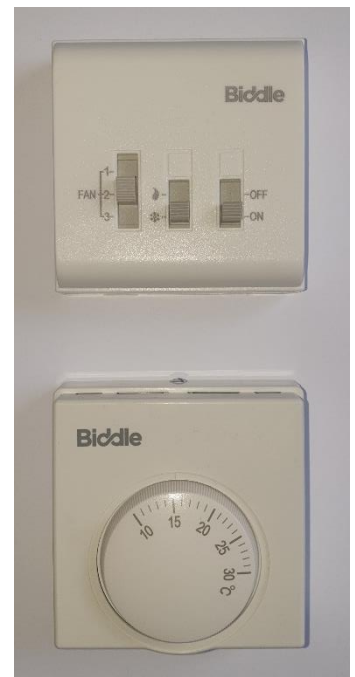

Remote thermostat

EC Products have a soft start feature that reduces the inrush current.

All units are suitable for 240 volt, 1 phase, 50Hz supply.

**WARNING** – if a remote on/off (T1) thermostat is installed with a remote switch box the on/off (T1) thermostat will remain live even when the on/off switch is in the ‘off’ position.



# Changing the Unit Handing

**1 Removing Access Panel**

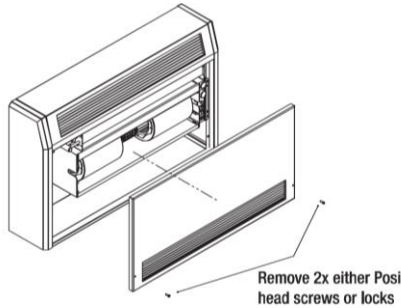

**2 Removing Top Panel**

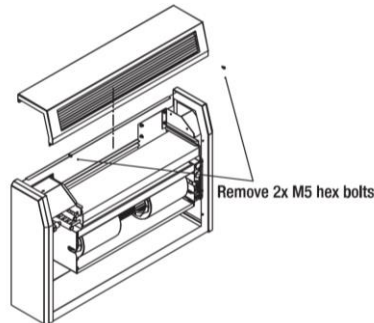

**3 Removing Filter**

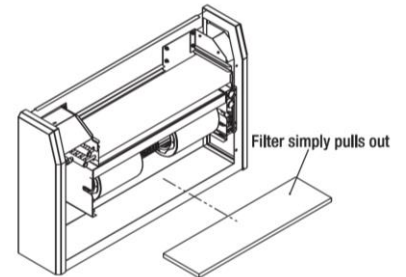

**4 Removing Blanking Plates**

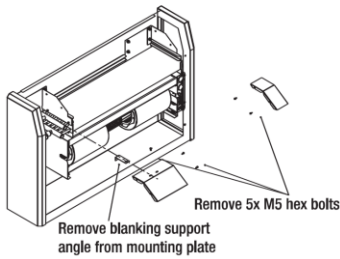

**5 Removing Coil**

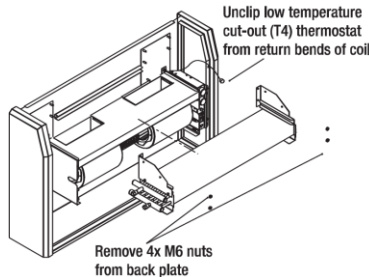

**6 Removing Electrics Box**

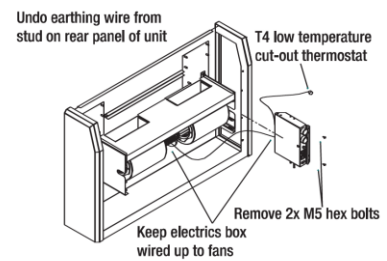

**7 Removing Fan Deck**

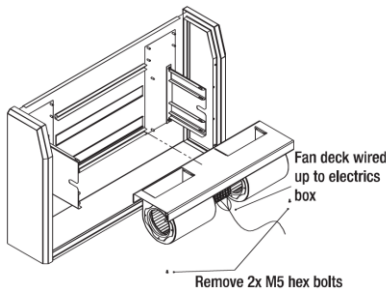

**8 Removing Fan Brackets**

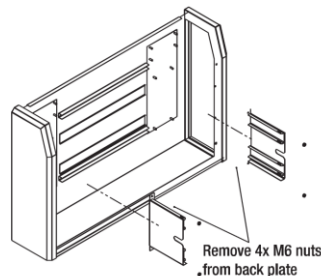

**9 Moving Fan Brackets**

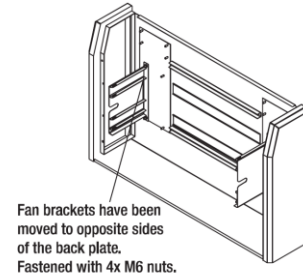

**10 Changing Coil Handing**

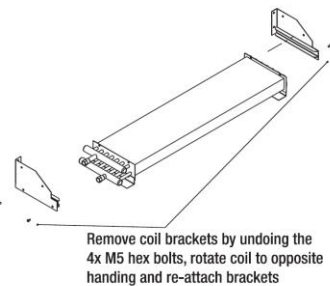

**11 Re-attaching Fan Deck**

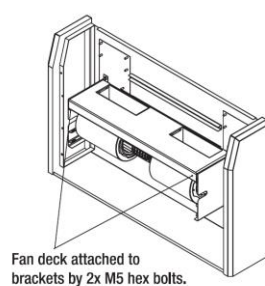

**12 Changing Electrics Box**

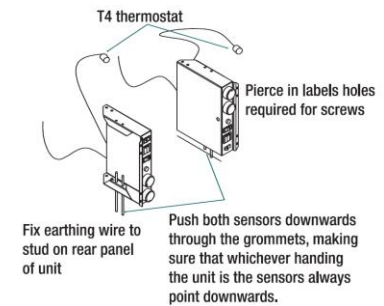

**13 Re-attaching Electrics Box Plates**

**14 Re-attaching Coil**

**15 Re-attaching Blanking Plates**

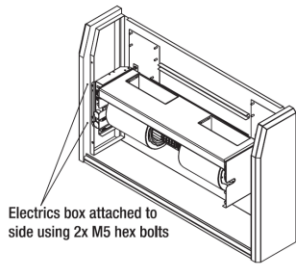

Electric box attached to side using 2x M5 hex bolts

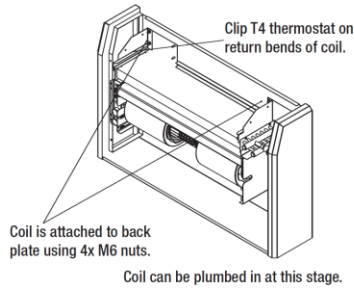

Coil is attached to back plate using 4x M6 nuts.

Coil can be plumbed in at this stage.

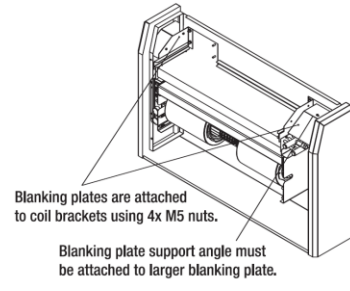

Blanking plates are attached to coil brackets using 4x M5 nuts.

Blanking plate support angle must be attached to larger blanking plate.

### 16 Re-attaching Filter Panel

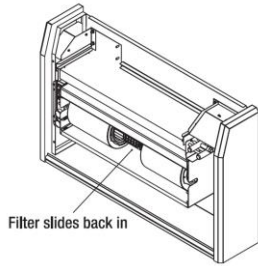

Filter slides back in

### 17 Re-attaching Top Panel

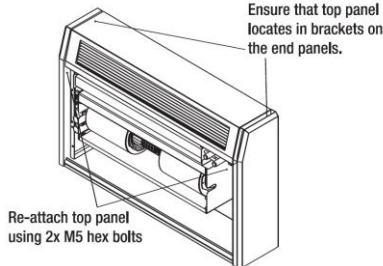

Re-attach top panel using 2x M5 hex bolts

Ensure that top panel locates in brackets on the end panels.

### 18 Re-attaching Access Panel

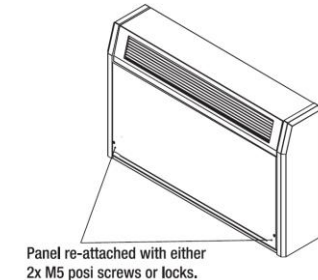

Panel re-attached with either 2x M5 posi screws or locks.

## Maintenance & Procedures

### Maintenance Schedule

As a guide the unit should be checked at the intervals detailed below to ensure the lifetime of the product is maximized and the efficiency isn't impacted detrimentally. The intervals suggested below are based on a normal environment and the unit should be checked frequently to ensure the recommendations are sufficient.

Failure to adhere to the below will reduce performance in the first instance and may impact on the product's warranty. Due to the potential presence of live parts within the casing, maintenance must only be carried out by a suitably qualified person.

	Every 3 Months	Every 6 Months	Every 12 Months
Filter	Yes		
Coil		Yes	
Fan		Yes	
Controls And Wiring			Yes

## Filters

The filter should be kept in good order to ensure the unit can operate effectively. Typical symptoms of dirty filters are a reduction in heating capacities, increased wear on the fan and increased noise levels. It is carried in a channel on the air inlet of the unit and is installed behind the main access panel manufactured from non-woven nylon and should be regularly cleaned or replaced.

The metal framed filter can be cleaned from the dirty side with a vacuum cleaner or can be partially cleaned by gentle tapping. After repeated cleaning, the filter performance will degrade, and then the filter media will need replacing. The cardboard frame panel filter is not designed to be cleaned and should be replaced when it becomes dirty.

The period between cleaning is dependent on operating conditions and should be carried out at appropriate intervals which vary from site to site. In a very dirty atmosphere, the filter will require frequent cleaning.

## Fan Deck Replacement

Internal to the unit are the fans that are double inlet single blower type driven by a single-phase motor pre-lubricated sealed-for-life sleeve bearings requiring no maintenance. The below process should be followed in the case of fan replacement during the lifetime of the product.

Step 1:- Safely isolate electrical supply

Step 2:- Remove access panel

Step 3:- Disconnect (unplug) the fan deck cables

Step 4:- Remove 2-off M5 hex head screws on either side of fan deck.

Step 5:- To install a new fan deck, repeat steps 1-4 in reverse and ensure the cables are fixed correctly so as not to be drawn into the fan when the unit is running.

## Coil Maintenance and Removal

Provided the filter is regularly serviced, the coil will require little or no attention. However, if the filter is allowed to get very dirty, some dust will percolate through, and become entrained between the fins. Should this occur, the coil should be cleaned by applying an air jet to the air leaving face.

Step 1:- Isolate any electrical supplies.

Step 2:- Remove the main access panel to gain access to the coil and top panel.

Step 3:- Isolate and drain coil.

Step 4:- Remove the 2-off M5 hex bolts that are now visible after removing access panel.

Step 4:- Remove top panel.

Step 5:- Disconnect the flow and return header connections

Step 6:- Remove the 4-off M6 nuts that hold coil mounting brackets to case that are now visible after removing top panel.

Step 7:- Lift out the coil and remove the 4-off M5 hex head screws from the coil fixing brackets.

Step 8:- To refit the coil, repeat steps 1-7 in reverse taking care to place the coil into the unit.

## Spares

When ordering spares from Biddle Air Systems, please quote the Sales Order number, the serial & model number of each unit concerned together with the individual article number for the component required (see tables below for article numbers). Details of the unit can be found on the rating plate located inside the unit.

Stock Code	Description	Stock Code	Description
94011000	915 Fan Deck - AC	94021005	915 CB Heating Coil
94012000	930 Fan Deck - AC	94022001	930 CB Heating Coil
94013000	935 Fan Deck - AC	94023002	935 CB Heating Coil
94014000	940 Fan Deck - AC	94024005	940 CB Heating Coil
94015000	975 Fan Deck - AC	94025001	975 CB Heating Coil
94011000 EC	915 Fan Deck - EC	94021004	915 H2 Heating Coil
94012000 EC	930 Fan Deck - EC	94022005	930 H2 Heating Coil
94013000 EC	935 Fan Deck - EC	94023001	935 H2 Heating Coil
94014000 EC	940 Fan Deck - EC	94024003	940 H2 Heating Coil
94015000 EC	975 Fan Deck - EC	94025000	975 H2 Heating Coil
94031000	915 Metal filter & frame	94031001	915 Cardboard frame filters (475 x 200)
94032000	930 Metal filter & frame	94032001	930 Cardboard frame filters (725 x 200)
94033001	935 Metal filter & frame	94033002	935 Cardboard frame filters (975 x 200)
94034000	940 Metal filter & frame	94034001	940 Cardboard frame filters (1225 x 200)
94035000	975 Metal filter & frame	94035001	975 Cardboard frame filters (1475 x 243)
94551000	915 Loose grilles with frame	94561007	915 Plinth (100mm)
94552000	930 Loose grilles with frame	94562000	930 Plinth (100mm)
94553001	935 Loose grilles with frame	94563000	935 Plinth (100mm)
94554001	940 Loose grilles with frame	94564002	940 Plinth (100mm)
94555002	975 Loose grilles with frame	94565011	975 Plinth (100mm)
95040000	Neon on/off switch	94040002	Remote on/off thermostat - adjustable
95040002	3 speed rocker switch	94040003	Remote on/off thermostat - tamperproof
95040023	Summer/Winter Switch	94040005	Remote speed change stat - adjustable
93040001	Fuse & fuse holder	94040006	Remote speed change stat - tamperproof
94040001	In-built on/off thermostat	94040017	Remote 3 speed, summer/winter controller
94040004	Inbuilt speed change thermostat	94030002	10m rolls of filter media
94040000	Low temp cut out thermostat	94040033	24v Relay & base
94040030	Adjustable T4 Low limit stat	94060004	Locks & Keys

## Wiring Diagrams

Wiring diagrams can be supplied on request. Please contact Biddle Sales.

Biddle Air Systems  
 St Mary's Road,  
 Nuneaton,  
 Warwickshire,  
 CV11 5AU

**Telephone:** +44 (0)24 7638 4233  
**E-mail:** sales@biddle-air.co.uk  
**Website:** www.biddle-air.co.uk